

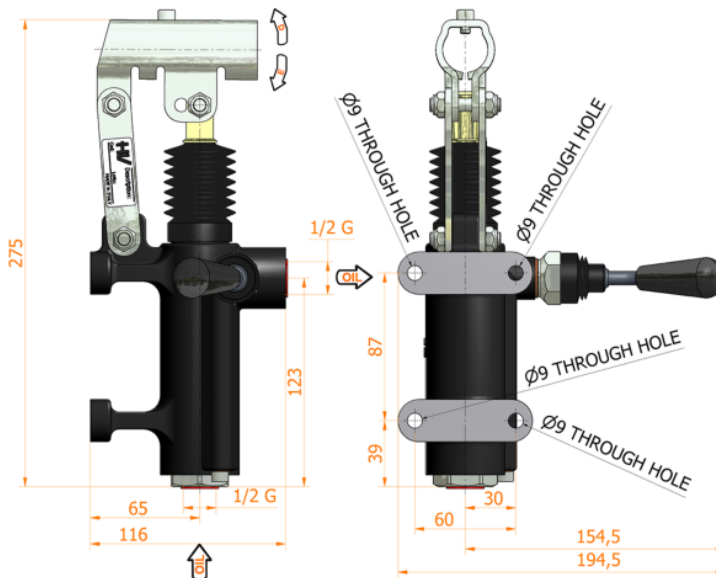

PMO 50 m-s

with normally closed manipulator
double acting hand pump for single acting cylinder
for fixing to wall

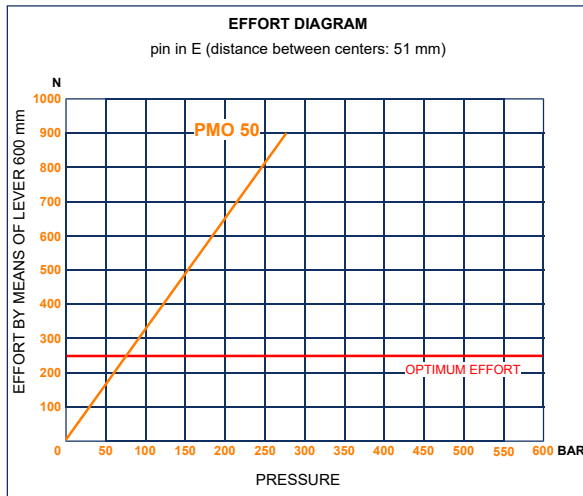
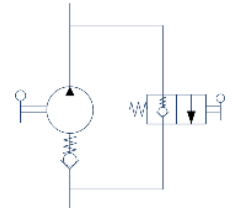

Specifications:

- Cast iron body
- Piston treated with Niploy
- White zinc plated support lever
- Lever connection Ø 27
- White zinc plated external parts
- Standard colour black

DISPLACEMENT cm ³	A mm	B mm	C mm	D °	E °	ACTUAL DISPLACEMENT cm ³	PRESSURE BAR		MASS KG	CODE WITHOUT BELLOWS	CODE WITH BELLOWS
							OPTIMAL	MAX			
50	--	--	--	38	37	43,825	80	280	3,400	6077.0007	6077.0034